



• **MODEM COUPLING TRANSFORMERS Compatible with 56kb/s technologies**

- Low Harmonic distortion.
- Flat Frequency / Phase Response

ELECTRICAL SPECIFICATIONS @ 25° :

SPECIFICATIONS		UT41200	UT41612	UT41654	UT41658	UT41632
Reflects 600Ω at PRI with RL=		600 Ω	560Ω	360Ω	510Ω	600Ω
Turns Ratio (PRI. : SEC.)		1:1±1%	1:1±2%	1:1±2%	1:1±2%	1:1±2%
D.C. Current in PRI.		none	none	none	none	none
Dielectric Test		4000Vac	3750Vac	1500Vac	5000Vac	4600Vac
Agency Approvals:		BABT,UL;VDE ¹	BABT;VDE ¹			BABT;VDE ¹
D.C. Resistance	PRI.	70Ω±10%	64Ω-72.5Ω	135Ω max.	100Ω typ.	45Ω±15%
	SEC.	70Ω±10%	64Ω-72.5Ω	135Ω max.	100Ω typ.	45Ω±15%
Insertion Loss	@ 1KHz 0dBm.			2.1dB max.		
	@ 2KHz 0dBm.	1.5dB max.	1.5dB max.		2.0dB max.	1.5dB max.
Frequency Response	@100Hz to 4KHz , ref 1KHz			±0.1dB max.	±0.8dB	
	@200Hz to 4KHz , ref 1KHz	±0.3dB	-1.0dB~+0.8dB			±0.4dB
Return Loss *	@ 200Hz to 3.5KHz			20dB min.		
	@ 200Hz to 4KHz	10dB min.	20dB min.		16dB min.	16dB min.
Total Harmonic Distortion	@ 150Hz, -3dBm.			-75dB max.	-75dB typ.	
	@ 450Hz, 0dBm.				-80dB typ.	
	@ 1KHz, 0dBm.	0.1% max.	0.1% max.			
Longitudinal Balance	@ 200Hz to 3.5KHz			60dB min.		
	@ 300Hz to 4KHz	85dB min.	80dB min.			
Shunt Inductance on PRI. (parallel mode)	@ 200Hz 10mV	2.8H min.		2.8H min.	11H typ.	1.48H min.
	@ 200Hz 20mV		4.0H min.			
	@1KHz 20mV		3.0H min.			
Shunt Resistance (parallel mode)	@ 200Hz 10mV				12KΩ min.	4.75KΩ min.
	@200Hz 20mV		20KΩ min.			
	@1KHz 20mV		25KΩ min.			
Leakage Inductance	@1KHz 1V, SEC. shorted	16mH max.	16mH~19mH	16mH max.	25mH typ.	

¹VDE-approval acc.DIN EN60950(VDE0805)

SCHEMATIC & DIMENSION : (UNIT : mm)

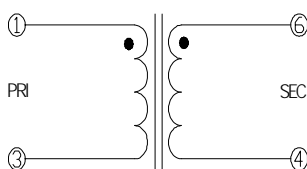
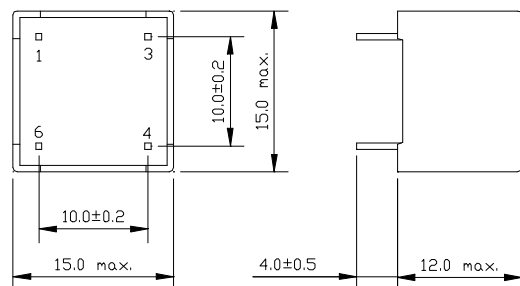
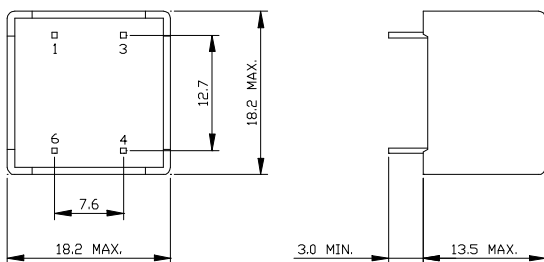

UT41200 UT41612
UT41654 UT41658

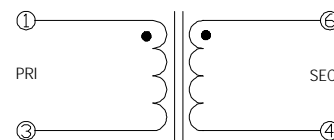

UT41632





TELECOMMUNICATION:

- **MODEM COUPLING TRANSFORMERS Compatible with 56kb/s technologies**

- Low Harmonic distortion.
- Flat Frequency / Phase Response

ELECTRICAL SPECIFICATIONS @ 25°C:

SPECIFICATIONS		UT68025	UT68039	UT68056	UT68079	UT69372
Reflects 600ohms at PRI with RL=		374Ω	301Ω	374Ω	301Ω	530Ω
Turns Ratio (PRI.:SEC.)		1:1±2%	1:1±2%	1:1±2%	1:1±2%	1:1±2%
D.C.Current in Pri.		none	none	none	none	none
Dielectric Test		1250Vac	1250Vac	1250Vac	1250Vac	1250Vac
Agency Approvals:						
D.C.Resistance	PRI.	108Ω±10%	150Ω±10%	108Ω±10%	150Ω±10%	43Ω±10%
	SEC.	120Ω±10%	150Ω±10%	120Ω±10%	150Ω±10%	43Ω±10%
Insertion Loss	@ 1KHz 0dBm.	2±0.25dB	3±0.5dB	2±0.25dB	3±0.5dB	1.0dB max.
Frequency Response	@ 200Hz to 4KHz , ref 1KHz	±0.25dB	±0.25dB	±0.25dB	±0.25dB	±0.2dB
Return Loss *	@ 300Hz		26dB min.			
	@ 1KHz			30dB typ.	30dB typ.	
	@ 3KHz		18dB min.			
	@ 300Hz to 3KHz	20dB min.				25dB min.
Total Harmonic Distortion	@ 600Hz, -10dBm.	-76dBmax.	-86dBmax.	-86dB typ.	-86dBmax.	-80dB typ.
Longitudinal Balance	@ 60Hz to 1KHz		60dB min.		60dB min.	
	@ 200Hz to 1KHz	60dB min.		60dB min.		60dB min.
	@ 1KHz to 4KHz	40dB min.	40dB min.	40dB min.	40dB min.	40dB min.
Shunt Inductance on PRI. (parallel mode)	@ 200Hz 1V	12H min.	20H min.			3H min.

SCHEMATIC & DIMENSION : (UNIT : mm)

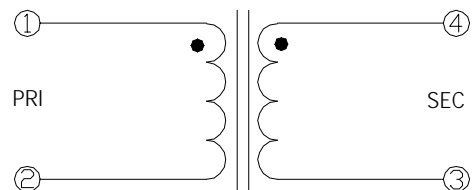
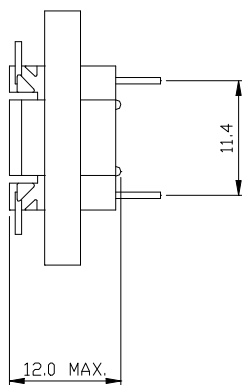
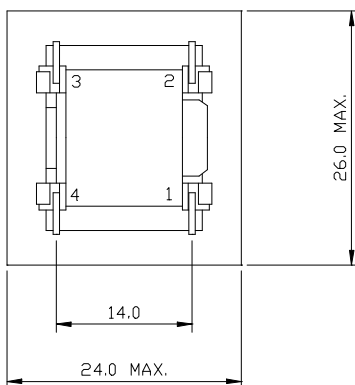

DATA SHEET 01-68
AUG./98;page2/6

UT68025 UT68039
UT68056 UT68079
UT69372



UMEC Europe
Universal Microelectronics

UMEC elektronische Komponenten GmbH
Kreuzenstraße 80 • D-74076 Heilbronn
Tel. 07131/76170 • Fax 07131/761720

Internet: <http://www.umec-europe.com>

e-mail: info@umec.de

<http://www.umec-web.com>



TELECOMMUNICATION:

• MODEM COUPLING TRANSFORMERS Compatible with 56kb/s technologies

- Low Harmonic distortion.
- Flat Frequency / Phase Response

ELECTRICAL SPECIFICATIONS @ 25°C:

SPECIFICATIONS		UT41650	UT41652	UT41652A
Reflects 600ohms at PRI with RL=		374Ω	301Ω	301Ω
Turns Ratio (PRI.:SEC.)		1:1±1%	1:1±1%	1:1±1%
D.C.Current in Pri.		none	none	none
Dielectric Test		1500Vac	1250Vac	1250Vac
Agency Approvals:			CSA "NRTL/C"	CSA "NRTL/C"
D.C.Resistance	PRI.	108Ω±10%	150Ω±10%	150Ω±10%
	SEC.	120Ω±10%	150Ω±10%	150Ω±10%
Insertion Loss		@ 1KHz 0dBm.	2.0dB	3.0dB max.
Frequency Response		@ 200Hz to 4KHz , ref 1KHz	±0.1dB	±0.2dB
Return Loss *	@ 200Hz to 4KHz		32dB min.	32dB min.
	@ 200Hz to 4KHz	20dB min.		
Total Harmonic Distortion	@ 150Hz, -3dBm.		-80dB max.	-80dB max.
	@ 150Hz, 0dBm.	-75dBmax.		
	@ 300Hz, 0dBm.	-86dBmax.		
	@ 300Hz, -10dBm.		-86dB max.	-86dB max.
Longitudinal Balance	@ 200Hz to 1KHz	60dB min.	80dB min.	80dB min.
	@ 1KHz to 4KHz	60dB min.	80dB min.	80dB min.
Shunt Inductance on PRI. (parallel mode)	@ 200Hz 1V	40H min.		
	@ 250Hz 1V		35H min.	35H min.

SCHEMATIC & DIMENSION : (UNIT : mm)

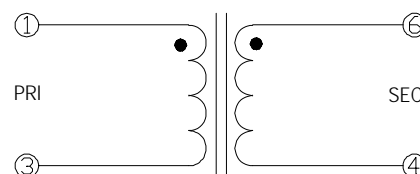
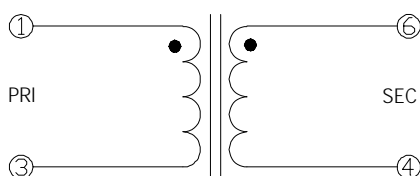
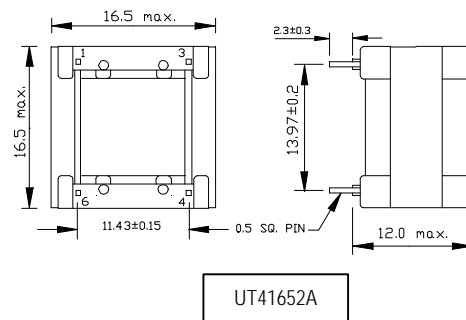
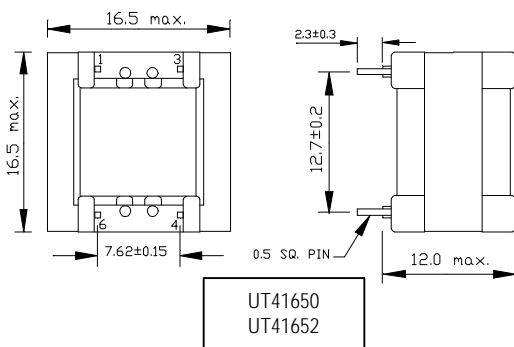



TELECOMMUNICATION:

- **MODEM COUPLING TRANSFORMERS Compatible with 56kb/s technologies**
- Low Harmonic Distortion
- Flat Frequency / Phase Response

ELECTRICAL SPECIFICATIONS @ 25°C:

SPECIFICATIONS		UT68262	UT68291
Reflects 600ohms at PRI with RL=		374Ω	348Ω
Turns Ratio (PRI.:SEC.)		1:1±2%	1:1±2%
D.C.Current in Pri.		none	none
Dielectric Test		1250Vac	3750Vac
Agency Approvals:			
D.C.Resistance	PRI.	103Ω nom.	152Ω±10%
	SEC.	128Ω nom.	151Ω±10%
Insertion Loss	@ 1KHz 0dB.	2.0±0.25dB	3.25dB max.
Frequency Response	@ 200Hz to 4KHz , ref 1KHz	±0.25dB	
	@ 300Hz to 4KHz , ref 1KHz		±0.5dB
Return Loss *	@ 300Hz to 3KHz	15dB min.	14dB min.
Total Harmonic Distortion	@ 600Hz, -10dBm.	-82dB max.	-83dB typ.
Longitudinal Balance	@ 60Hz to 1KHz		60dB min.
	@ 200Hz to 1KHz	60dB min.	
	@ 1KHz to 4KHz	40dB min.	60dB min.

SCHEMATIC & DIMENSION : (UNIT : mm)

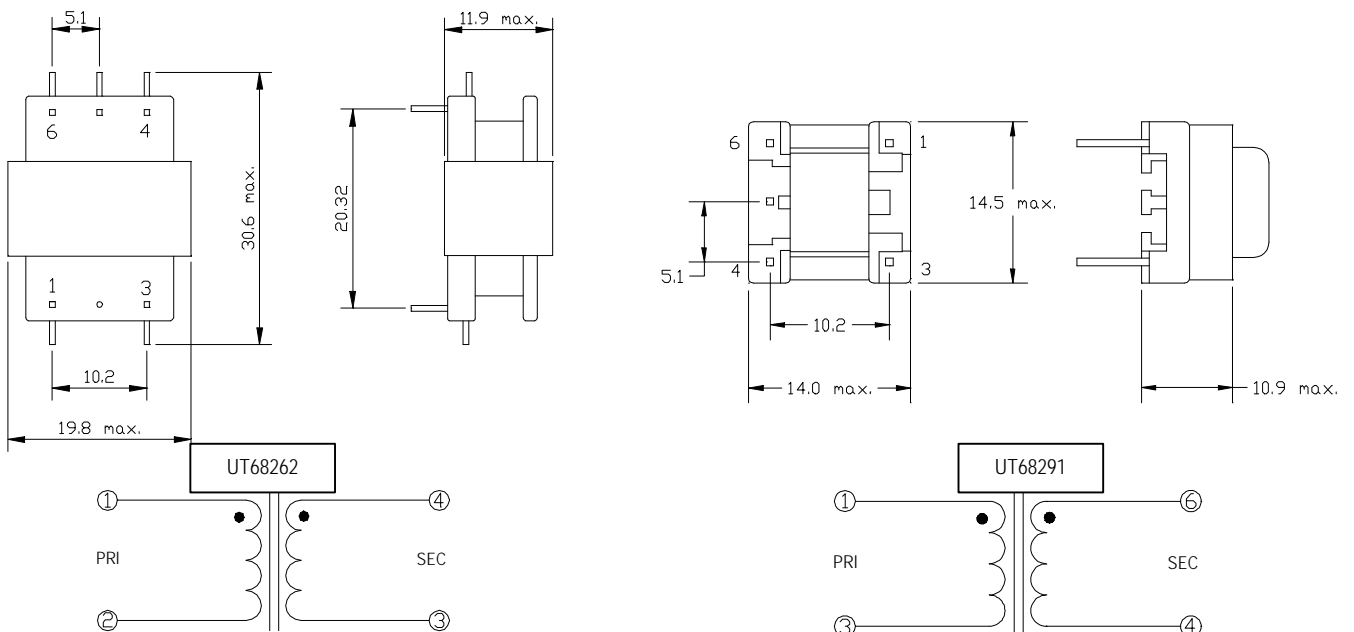

DATA SHEET 01-68
AUG./98 4/6



UMEC Europe
Universal Microelectronics

Internet: <http://www.umec-europe.com>
<http://www.umec-web.com>

UMEC elektronische Komponenten GmbH
Kreuzenstraße 80 • D-74076 Heilbronn
Tel. 07131/76170 • Fax 07131/761720

e-mail: info@umec.de



TELECOMMUNICATION:

• MODEM COUPLING TRANSFORMERS Compatible with 56kb/s technologies

- Low Harmonic Distortion.
- Flat Frequency / Phase Response
- Surface Mountable

ELECTRICAL SPECIFICATION @ 25°C

SPECIFICATIONS		UT68422	UT68455
Reflects 600ohms at PRI with RL=		392Ω	392Ω
Turns Ratio (PRI.:SEC.)		1:1±2%	1:1±1%
D.C.Current in Pri.		none	None
Dielectric Test		1250Vac	1250Vac
Agency Approvals:			
D.C.Resistance	PRI.	100Ω ±10%	100Ω ±10%
	SEC.	120Ω ±10%	122Ω ±10%
Insertion Loss	@ 1KHz 0dBm.	2.0dB max.	2.0dB max.
Frequency Response	@ 300Hz to 3.5KHz , ref 1KHz	±0.2dB	±0.2dB
Return Loss *	@ 300Hz to 3KHz	25dB min.	25dB min.
Total Harmonic Distortion	@ 600Hz, -10dBm.	-80dB typ.	-86dB max.
Longitudinal Balance	@ 60Hz to 1KHz	60dB min.	
	@ 200Hz to 1KHz		60dB min.
	@ 1KHz to 4KHz	40dB min.	40dB min.

SCHEMATIC & DIMENSION : (UNIT : mm)

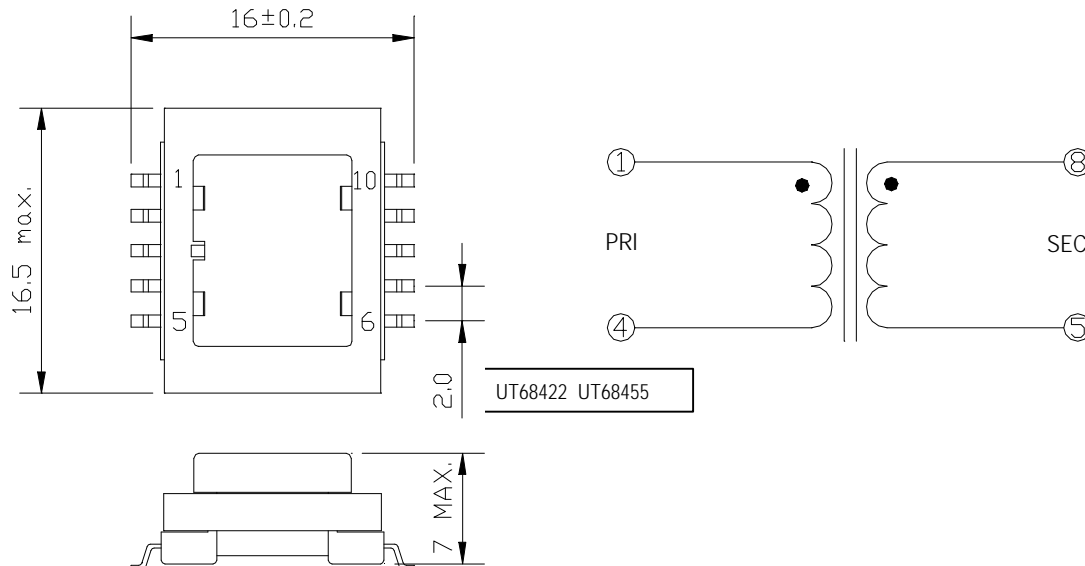

DATA SHEET 01-68 AUG./98
5 OF 6



UMEC Europe
Universal Microelectronics

Internet: <http://www.umec-europe.com>
<http://www.umec-web.com>

UMEC elektronische Komponenten GmbH
Kreuzenstraße 80 • D-74076 Heilbronn
Tel. 07131/76170 • Fax 07131/761720

e-mail: info@umec.de



- **MODEM COUPLING TRANSFORMERS Compatible with 56kb/s technologies**

RETURN LOSS TEST CIRCUITS

600Ω Match Recommended Circuit Description:

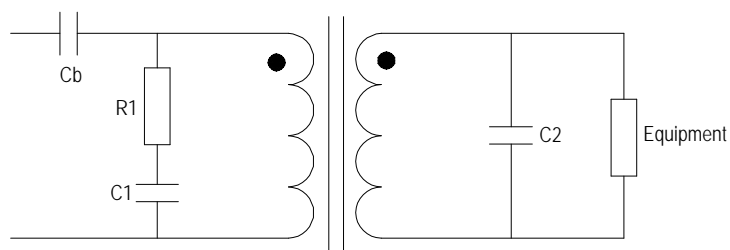

UM Part No.	Ref. Impedance Values	Recommended Circuit Values				
		Cb (uF)	R1 (Ω)	C1 (nF)	C2 (nF)	Equipment (Ω)
UT41200	600Ω					600Ω
UT41612	600Ω	6.8uF		27nF	33nF	560Ω
UT41632	600Ω					600Ω
UT41650	600Ω					374Ω
UT41652	600Ω			12nF		301Ω
UT41652A	600Ω			12nF		301Ω
UT41654	600Ω					360Ω
UT41658	600Ω	22uF	330Ω	33nF	39nF	510Ω
UT68025	600Ω					374Ω
UT68039	600Ω					301Ω
UT68056	600Ω					374Ω
UT68079	600Ω					301Ω
UT68262	600Ω					374Ω
UT68291	600Ω					348Ω
UT68422	600Ω					392Ω
UT68455	600Ω					392Ω
UT69372	600Ω					530Ω

